

30V N-Ch Power MOSFET

Feature

- ◇ High Speed Power Switching, Logic Level
- ◇ Enhanced Avalanche Ruggedness
- ◇ 100% UIS Tested, 100% Rg Tested
- ◇ Lead Free, Halogen Free

V_{DS}		30	V
$R_{DS(on),typ}$	$V_{GS}=10V$	2.8	$m\Omega$
I_D (Silicon Limited)		37	A

Application

- ◇ Hard Switching and High Speed Circuit
- ◇ DC/DC in Telecoms and Industrial

DFN3*3

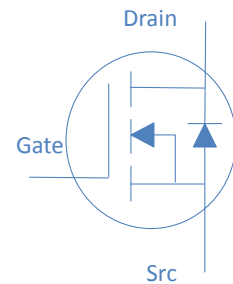
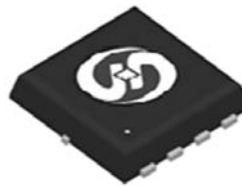

Part Number	Package	Marking
HTM035N03	DFN3*3	TM035N03

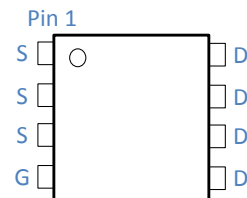

Absolute Maximum Ratings at $T_j=25^\circ\text{C}$ (unless otherwise specified)

Parameter	Symbol	Conditions	Value	Unit
Continuous Drain Current (Silicon Limited)	I_D	$T_C=25^\circ\text{C}$	37	A
		$T_C=100^\circ\text{C}$	25	
Drain to Source Voltage	V_{DS}	-	30	V
Gate to Source Voltage	V_{GS}	-	± 20	V
Pulsed Drain Current	I_{DM}	-	148	A
Avalanche Energy, Single Pulse	E_{AS}	$L=0.1\text{mH}, T_C=25^\circ\text{C}$	68.4	mJ
Power Dissipation	P_D	$T_C=25^\circ\text{C}$	2.5	W
Operating and Storage Temperature	T_J, T_{stg}	-	-55 to 150	$^\circ\text{C}$

Absolute Maximum Ratings

Parameter	Symbol	Max	Unit
Thermal Resistance Junction-Ambient	$R_{\theta JA}$	50	$^\circ\text{C/W}$
Thermal Resistance Junction-Case	$R_{\theta JC}$	6	$^\circ\text{C/W}$

Electrical Characteristics at $T_J=25^{\circ}\text{C}$ (unless otherwise specified)
Static Characteristics

Parameter	Symbol	Conditions	Value			Unit
			min	typ	max	
Drain to Source Breakdown Voltage	$V_{(BR)DSS}$	$V_{GS}=0V, I_D=250\mu A$	30	-	-	V
Gate Threshold Voltage	$V_{GS(th)}$	$V_{GS}=V_{DS}, I_D=250\mu A$	1	1.5	3	
Zero Gate Voltage Drain Current	I_{DSS}	$V_{GS}=0V, V_{DS}=24V, T_J=25^{\circ}\text{C}$	-	-	1	μA
		$V_{GS}=0V, V_{DS}=20V, T_J=125^{\circ}\text{C}$	-	-	25	
Gate to Source Leakage Current	I_{GSS}	$V_{GS}=\pm 20V, V_{DS}=0V$	-	-	± 100	nA
Drain to Source on Resistance	$R_{DS(on)}$	$V_{GS}=10V, I_D=18A$	-	2.8	3.5	m Ω
		$V_{GS}=4.5V, I_D=14A$	-	3.3	4	
Transconductance	g_{fs}	$V_{DS}=5V, I_D=18A$	-	25	-	S
Gate Resistance	R_G	$V_{GS}=15mV, V_{DS}=0V, f=1MHz$	-	1.6	-	Ω

Dynamic Characteristics

Input Capacitance	C_{iss}	$V_{GS}=0V, V_{DS}=15V, f=1MHz$	-	2979	-	pF
Output Capacitance	C_{oss}		-	381	-	
Reverse Transfer Capacitance	C_{rss}		-	224	-	
Total Gate Charge	$Q_g(10V)$	$V_{DD}=15V, I_D=30A, V_{GS}=10V$	-	44.6	-	nC
	$Q_g(4.5V)$		-	21.2	-	
Gate to Source Charge	Q_{gs}		-	8.3	-	
Gate to Drain (Miller) Charge	Q_{gd}		-	6.5	-	
Turn on Delay Time	$t_{d(on)}$	$V_{DD}=15V, I_D=1A, V_{GS}=10V,$ $R_G=2.7\Omega,$	-	15	-	ns
Rise time	t_r		-	10	-	
Turn off Delay Time	$t_{d(off)}$		-	50	-	
Fall Time	t_f		-	10	-	

Reverse Diode Characteristics

Diode Forward Voltage	V_{SD}	$V_{GS}=0V, I_F=37A$	-		1.3	V
Reverse Recovery Time	t_{rr}	$I_F=37A, di_F/dt=100A/\mu s$	-	32	-	ns
Reverse Recovery Charge	Q_{rr}		-	12	-	nC

Figure 1. Typical Output Characteristics

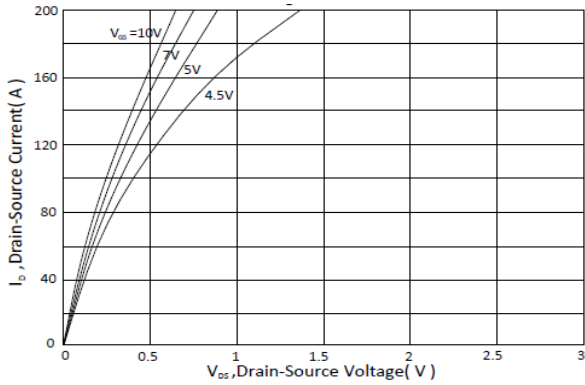

Figure 2. On-Resistance vs. Gate-Source Voltage

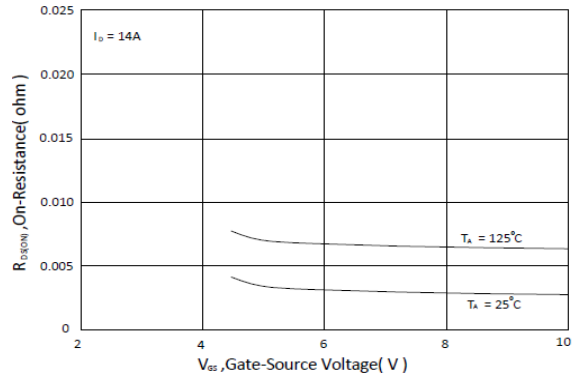

Figure 3. On-Resistance vs. Drain Current and Gate Voltage

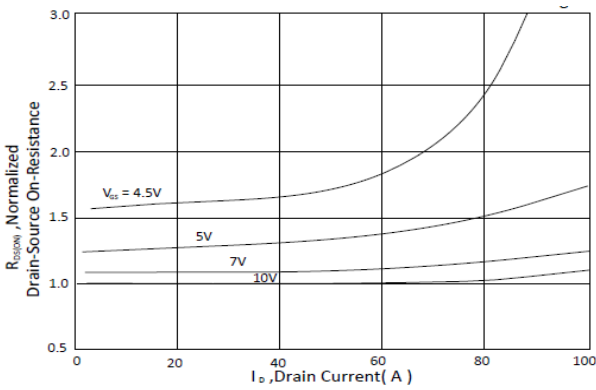

Figure 4. Normalized On-Resistance vs. Junction Temperature

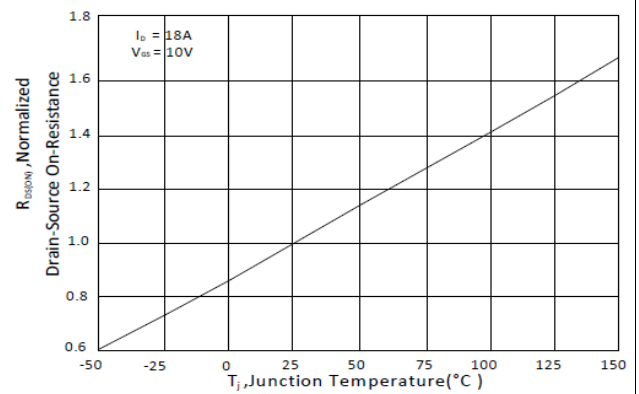

Figure 5. Typical Transfer Characteristics

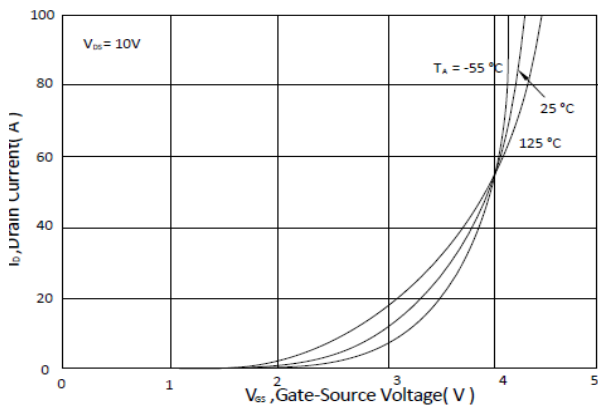

Figure 6. Typical Source-Drain Diode Forward Voltage

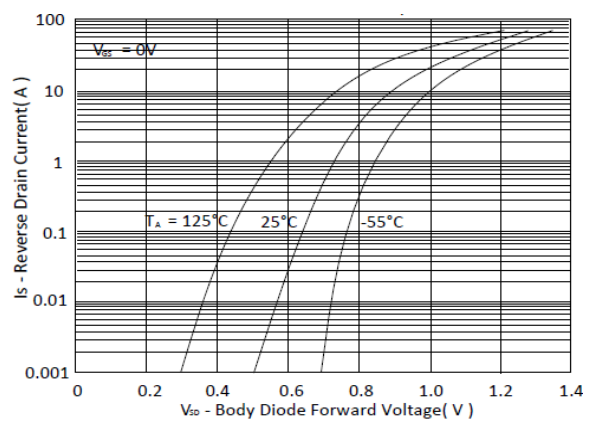

Figure 7. Typical Gate-Charge vs. Gate-to-Source Voltage

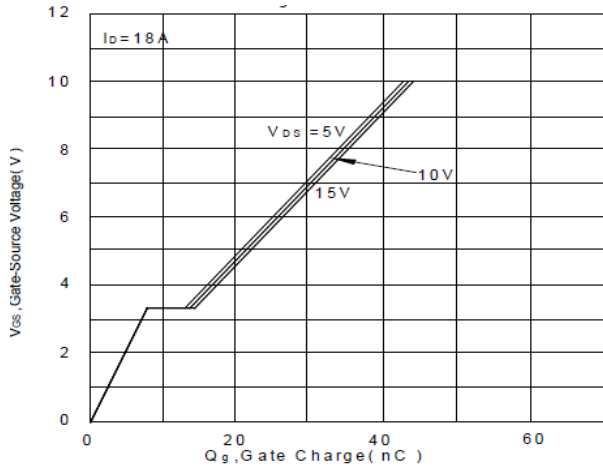

Figure 8. Typical Capacitance vs. Drain-to-Source Voltage

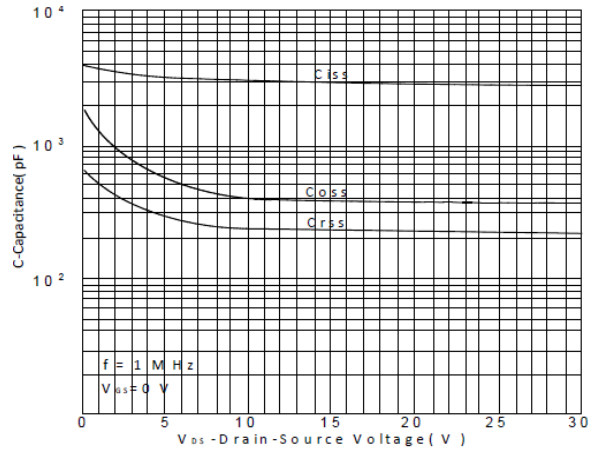

Figure 9. Maximum Safe Operating Area

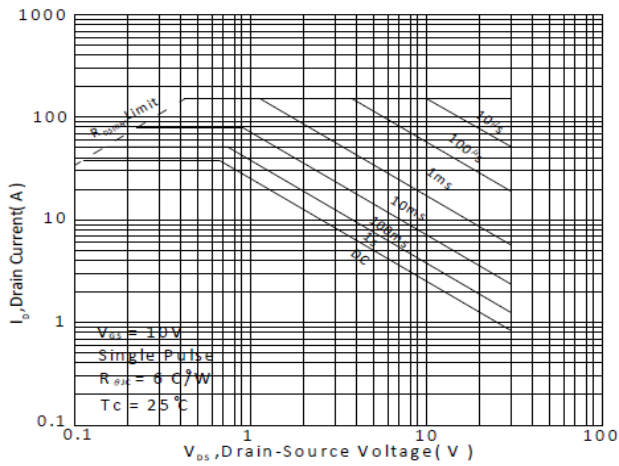

Figure 10. Single Pulse Maximum Power Dissipation

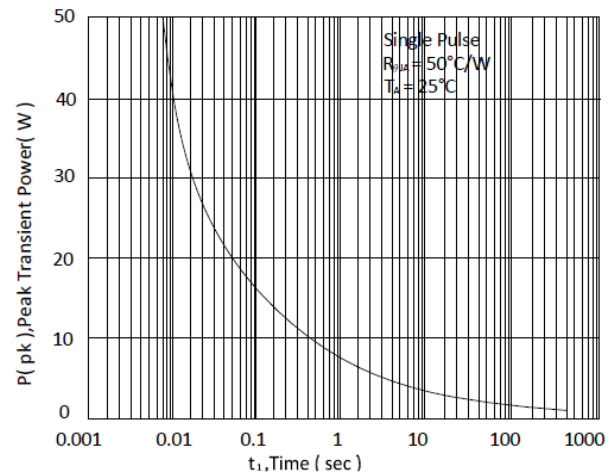
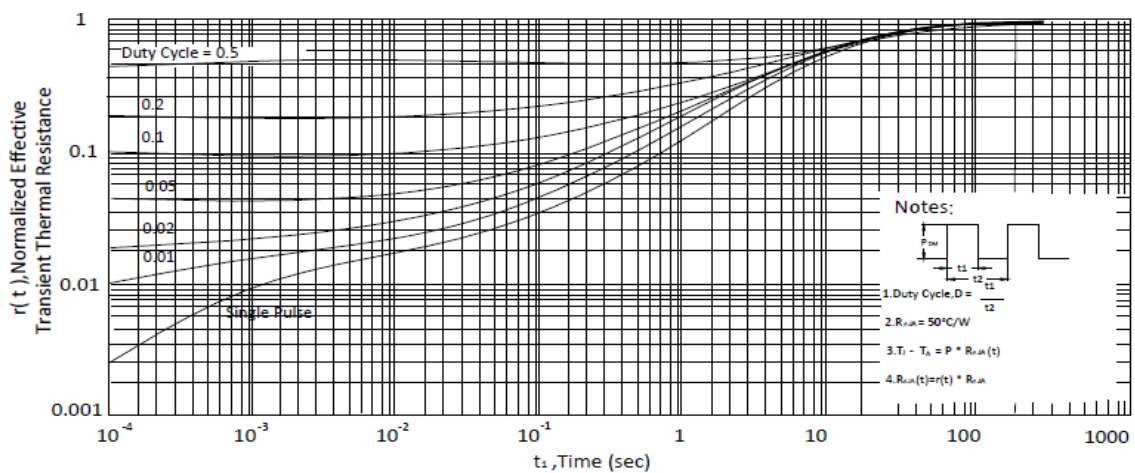
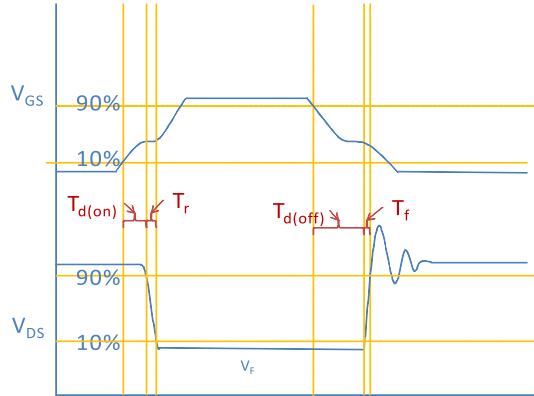
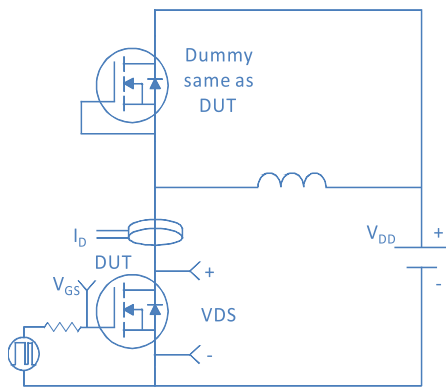

Figure 11. Normalized Maximum Transient Thermal Impedance, Junction-to-Ambient



Inductive switching Test



Gate Charge Test

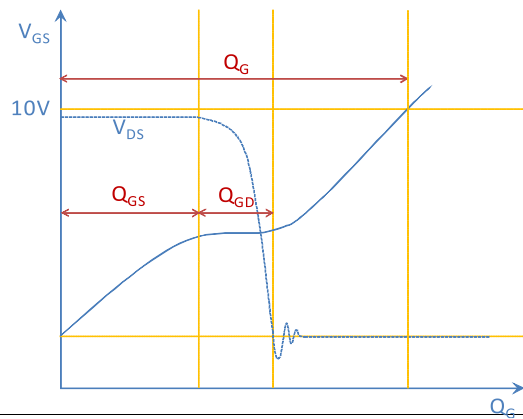
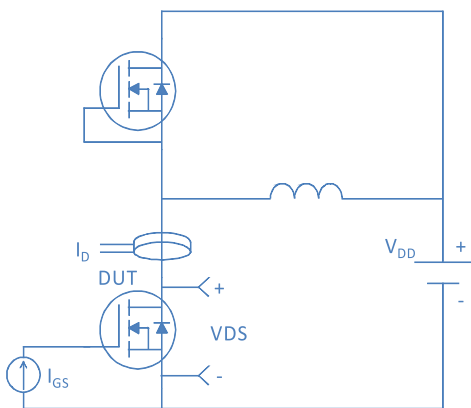

Uclamped Inductive Switching (UIS) Test

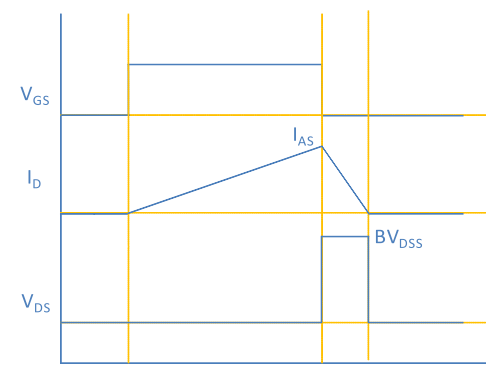

Diode Recovery Test

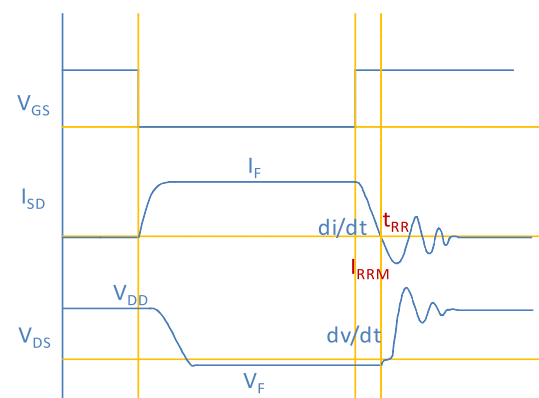
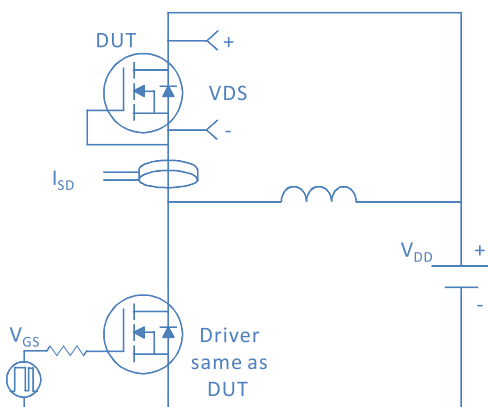

Package Outline

DFN3*3_P, 8leads

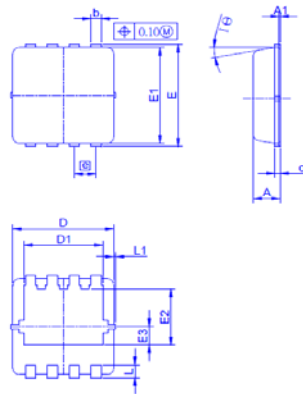

Dimension in mm

Dimension	A	A1	b	c	D	D1	E	E1	E2	E3	e	L	L1	θ1
Min.	0.70	0	0.24	0.10	2.95	2.25	3.15	2.95	1.65			0.30		0°
Typ.	0.80		0.30	0.152	3.00	2.35	3.20	3.00	1.75	0.575	0.65	0.40	0.13	10°
Max.	0.90	0.05	0.37	0.25	3.15	2.45	3.40	3.15	1.96			0.50		12°